

**EAST JORDAN IRON WORKS, INC.**  
 P.O. BOX 439  
 EAST JORDAN, MI. 49727  
 1-800-874-4100  
 FAX 231-536-4458

DRAWN SBB	DATE 04/18/05
APPROVED	DATE

**WATER TIGHT ASSEMBLY**

PRODUCT NO.  
**00104509**

CATALOG NO.  
 1040APT  
 1045ZPT

REF. PRODUCT DRAWING  
 00104512  
 00104174

EST. WT.  
 COVER: 150 LBS 68kg  
 FRAME: 165 LBS 75kg  
 UNIT: 315 LBS 143kg

OPEN AREA  
 N/A

MAT'L SPEC.  
 COVER - GRAY IRON  
 ASTM A48 CL35B  
 FRAME - GRAY IRON  
 ASTM A48 CL35B

LOAD RATING  
**HEAVY DUTY (H-25)**

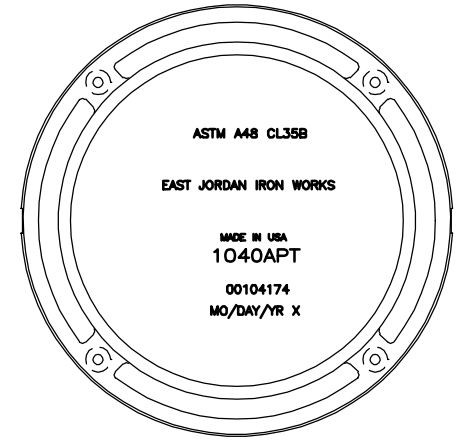
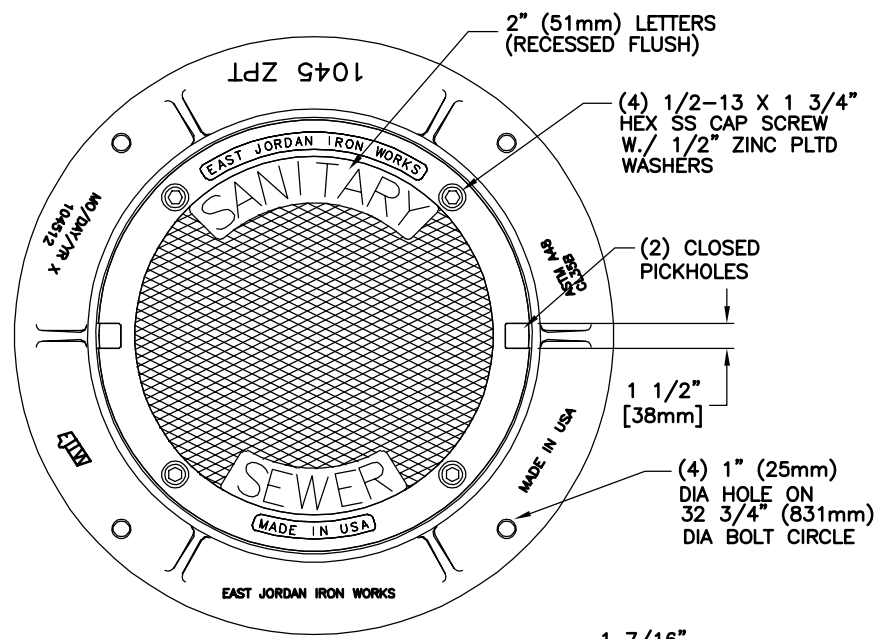

**BOTTOM VIEW**

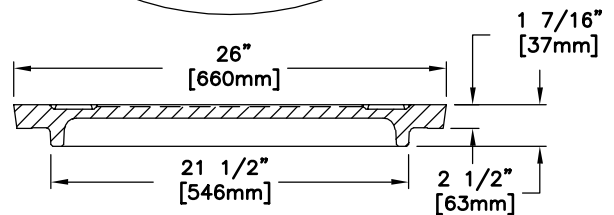

**COVER SECTION**

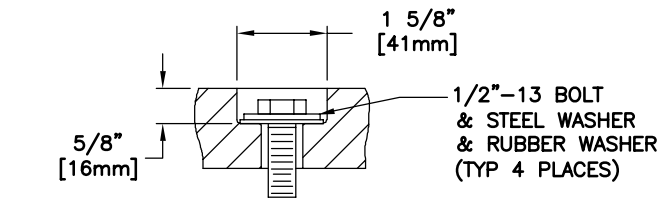

**BOLT DETAIL**

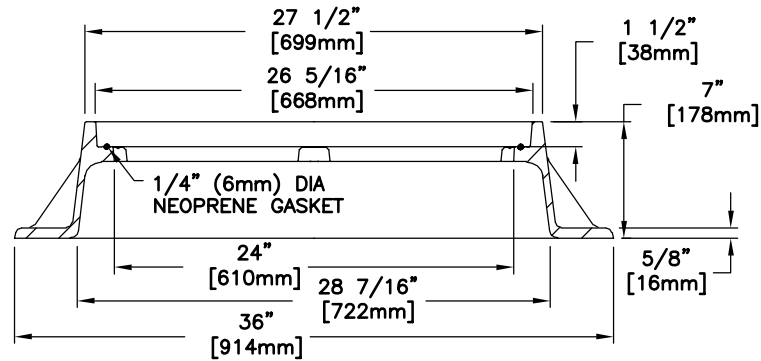

**FRAME SECTION**

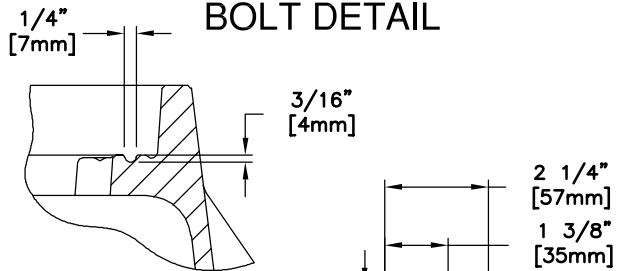

**GROOVE DETAIL**

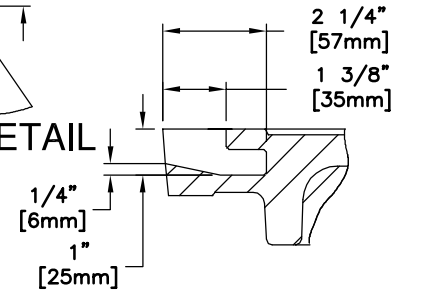

**PICKHOLE DETAIL**